

## User manual

The Dyson cordless vacuum cleaner in an upright position with the wand and cleaner head attached.

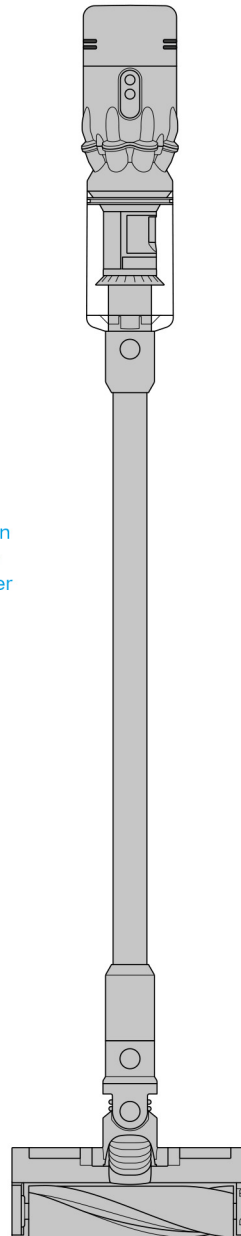

---

### Contents

In the box

Getting started

Caring for your floors

Charging your machine

Emptying your bin

Cleaning your bin

Clearing blockages

Clearing blockages from your

Hair screw tool

Washing your filter

Washing your Fluffy Optic™ cleaner  
head brush bar

Cleaning your tools

Looking after your machine

# In the box

Main body showing the handle and bin attached.

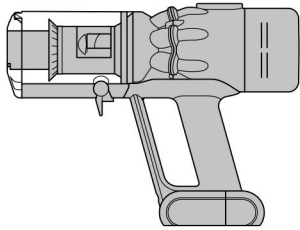

**Vacuum cleaner**

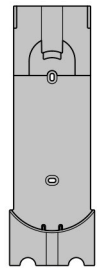

A rectangular dock that needs to be fixed to a wall with screws.

**Wall dock**

The Dyson cordless vacuum drops into the wall-mounted charging dock, ready for your next clean.

A soft fluffy brush bar housed within the cleaner head. There is an electrical connector end that can attach to the end of the wand or directly to the machine.

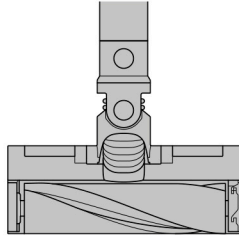

**Fluffy Optic™ cleaner head**

The Fluffy Optic™ cleaner head makes invisible dust visible on hard floors.

The narrow connector end at the top, this connects to the bin and the wider end at the bottom that connects to the cleaner head or tool.



**Wand**



The charger is a one piece unit with the plug, connector end and cable.

**Charger**

Charges your vacuum with or without a dock.

Some tools may not be included, small details may vary from those shown.

You can buy additional tools at [www.dyson.hk/en-HK](http://www.dyson.hk/en-HK).



The Scratch-free dusting brush has a head made of soft bristles for cleaning delicate surfaces.

**Scratch-free dusting brush**

Gentle on delicate surfaces. Self-cleaning - a rotating cuff keeps the soft bristles clear of dust.



A flexible hose engineered from tough wire and durable plastic.

**Extension hose**

Adds up to 61cm of flexible reach to any tool attachment, to clean up high or down low in your home or car.

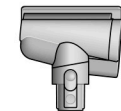

A small cleaner head with an angled body housing the motor and an electrical connector to attach to the wand or directly to the machine.

**Hair screw tool**

Anti-tangle conical brush bar spirals hair off and into the bin. Motor-driven cleaning for smaller spaces.



This tool is angled and has a nozzle end.

**Worktop tool**

Engineered for cleaning kitchen worktops, tables and hard surfaces.

A plastic clip that attaches to the wand.



**Wand clip**

Clips to your vacuum's wand to hold tools.



The Awkward gap tool is long and slim, with a 22° degree twist for cleaning tight gaps and hard-to-reach places.

**Awkward gap tool**

Long and narrow, with a 22° twist to clean car storage compartments, tight gaps and hard-to-reach places.

# Getting started



**Power button**  
Press the Power button once for comfortable, continuous cleaning.

We've removed the trigger, so you can swap hands easily while cleaning around obstacles.

**MAX**



**Power modes**  
Press the button to change power modes.

**Max mode**  
Delivers maximum power. For intensive cleaning of ground-in dirt.

**Eco mode**  
The optimum balance of power and run time.

Location of the power button on the top of the machine.

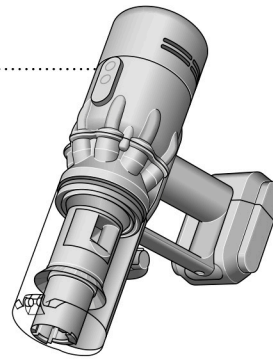

The main body with the power button and mode button on the top of the machine and bin with the bin base closed.

The connection of the wand onto the main body, with the wand release button aligned with the buttons on the handle of the main body.

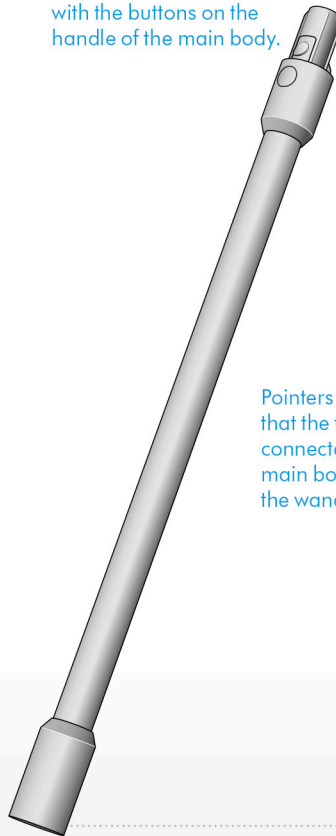

The main body of the Dyson vacuum connects to the Fluffy Optic™ cleaner head floor tool.

Pointers to demonstrate that the tools can be connected directly to the main body or to the end of the wand.

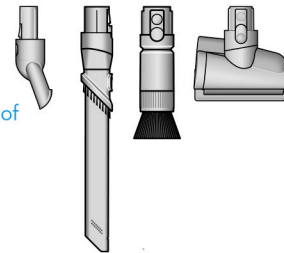

Arrow showing the end of the wand connecting to the cleaner head.

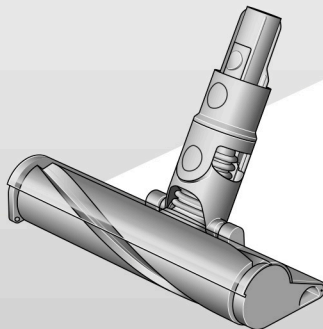

**Fluffy Optic™ cleaner head**  
The Fluffy Optic™ cleaner head makes invisible dust visible on hard floors.

# Caring for your floors

Check that the underside of the cleaner head or tool is clean and free from any objects that may cause damage.

Before vacuuming your flooring, rugs, and carpets, check the manufacturer's recommended cleaning instructions.

This machine is designed for use on hard floors. The brush bar on your machine can damage certain flooring. Some rug materials may fuzz if a rotating brush bar is used when vacuuming. If this happens, we recommend vacuuming without the motorised floor tool and consulting with your flooring manufacturer.

---

## Charging your machine

For the best experience, we recommend fully charging your machine, and any additional batteries, as soon as you open the box and after every clean.

The LED light on the end of the handle will flash when the power is running low and you need to put your battery on to charge.

Connect the charger directly to the charging point on the base of the handle of your machine. You can also connect to your dock as shown in the installation instructions supplied with your dock.

The LED light on the end of the handle will pulse with a blue LED light when charging, and the light will go out when fully charged.

It can take up to 3.5 hours to fully charge your battery. Your battery has been designed to be left on charge.

Your machine won't operate or charge if the ambient temperature is below 5°C (41°F). This is designed to protect both the motor and battery.

You can help prolong the battery life by leaving your machine to cool down before recharging.

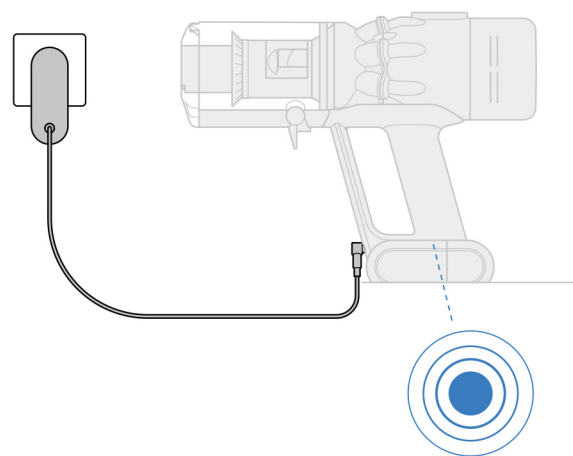
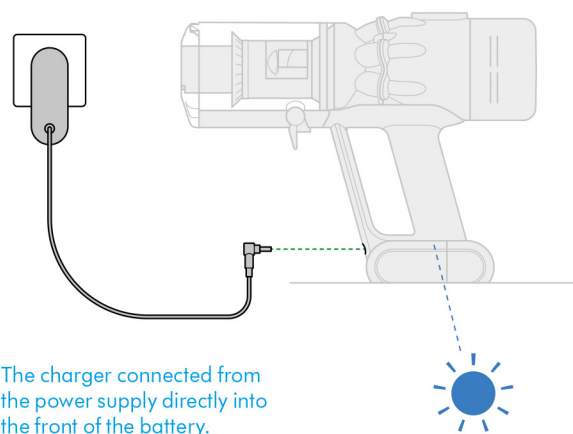

# Emptying your bin

Empty your bin as soon as the dirt reaches the MAX mark.  
You may need to clean the filter more often if you use your machine with a full bin.

## Remove your wand

Press the red wand release button, on the top of the wand, and pull the wand away from the bin.

## Release the dirt

Hold the machine over the bin, pointing downwards.

Firmly push the red bin release button. The bin will slide down, cleaning the shroud as it goes, and the bin base will open.

The bin base won't open if the red bin release button isn't pushed down all the way.

## To remove the bin for emptying:

If the bin doesn't empty fully, remove the bin and empty the dirt.

Press the red button located on the bin runner to release the bin and slide your bin off the runner.

## Minimise dust contact

Cover your bin tightly in a dust proof bag while you empty. Remove your bin carefully, seal the bag tightly and dispose.

## Replace your bin

If you have removed your bin, slide it back on to the runner. Make sure that the bin and lid are both securely in position.

Push the bin base upwards until the bin and lid both click into place.  
Reconnect the wand.

## Close the bin

Push the bin base upwards until your bin and bin base click into place.

The MAX mark on the bin of the machine, showing that the dirt should not be filled over the Max mark when the machine is at the angle of normal use.



Illustration of the bin being emptied.

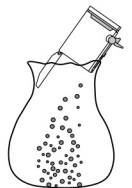
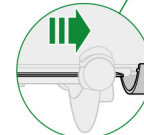
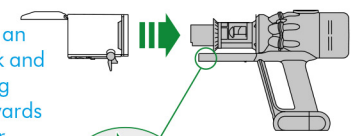
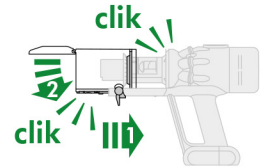

Illustration of the bin being emptied into a bag.

The bin lid closing with an audible click and the bin being pushed upwards with another click once it is fully in place.



Two images of the bin with arrows showing the bin lid closing and a click symbol and the bin being pushed upwards with another click symbol.



# Cleaning your bin

Don't put any part of your machine in a dishwasher or use detergents, polishes or air fresheners.

## Clean your bin

If it is necessary to clean your bin, empty it as shown in the 'Emptying your bin' section.

Press the red button located on the bin runner to release the bin and slide your bin off the runner.

To clean your bin, you can use a damp, lint-free cloth, or run it under a stream of water. Never fully submerge your bin under water. Once your bin is cleaned leave to dry before reattaching.

Make sure that your bin and seals are completely dry before replacing.

## Replace your bin

Insert the spine on to the bin runner.

Close your bin by pushing the bin base upwards until the bin and bin base click into place.

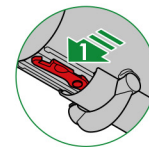

The bin being pushed back into position on the bin runner.

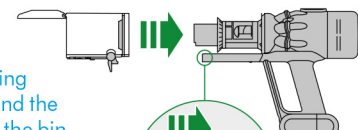
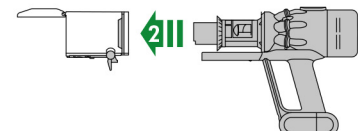

The bin being removed and the location of the bin release lever on the underside of the bin runner.

# Clearing blockages

If your machine detects a blockage, the motor will pulse six times. You won't be able to use your machine until the blockage has been cleared.

If you try to use your machine when the motor is pulsing, it will automatically cut out.

Leave your machine to cool down before looking for blockages.

Disconnect your machine from the charger before looking for blockages. Be aware of sharp objects.

Leave your machine to cool down before looking for blockages.

Don't use your machine when looking for blockages as this could cause injury.

With the bin removed, check for blockages, paying particular attention to the air inlet, located at on the right-hand side of the machine just below the point where the bin joins the main body of the machine.

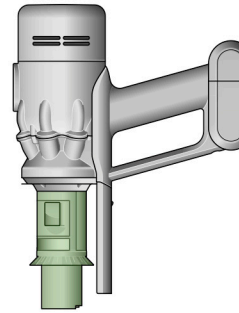

Check for blockages in the filter end and bin ends of the machine.



The bin being removed and the location of the bin release lever on the underside of the bin runner.

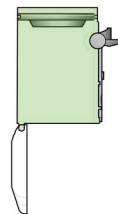

With the wand removed from the machine, check for blockages at both ends of the wand.

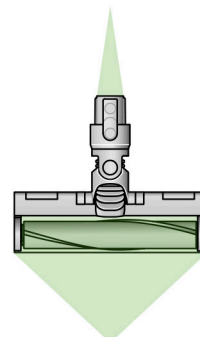

Turn the cleaner head over to check for obstructions on the brush bar and air inlet.

Remove any obstructions from the brush bar.



# Clearing blockages from your Hair screw tool

Your Hair screw tool doesn't have a washable brush bar. To maintain optimum performance, check your brush bar regularly and clear any obstructions.

Make sure your machine is disconnected from the charger.

## Remove the cover and brush bar

Remove the Hair screw tool from the wand or machine.

Push the base plate open. Press the red lever down to release the cleaner head cover.

Pull the cleaner head cover off the main body of the tool.

## Look for obstructions

Pull your brush bar firmly to remove it from the main body.

Check and remove any obstructions from all three parts of your Hair screw tool.

Your Hair screw tool isn't washable. Wipe over with a damp lint-free cloth.

Don't put any part of your machine in a dishwasher or use detergents, polishes or air fresheners.

## Reassemble Hair screw tool

Put your brush bar back into position and press firmly until it clicks back into position.

Check the red locking lever is in the unlocked position. Align the cleaner head cover with the guide on the main body. Push it down until it clicks into position.

Push the red locking lever up until it clicks into position and push the base plate back into place.

Location of the lever to release the brush bar is located at the back of the Hair screw tool.

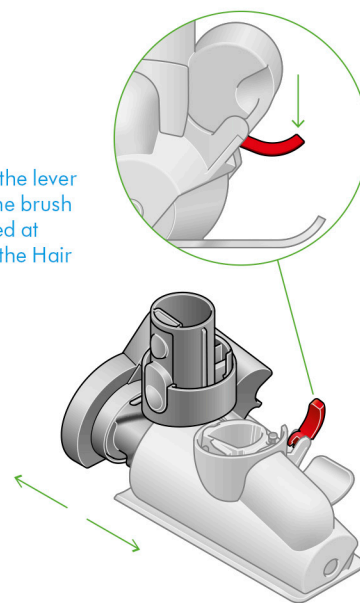

Slide the housing back on to the brush bar and push the lever on the back of the Hair screw tool upwards to lock.

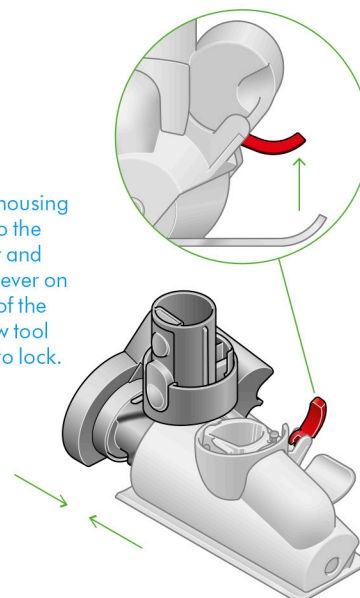

# Washing your filter

Wash your filter at least once a month to maintain optimum suction power.

For more information and support videos for your machine go online: [www.dyson.hk/en-HK](http://www.dyson.hk/en-HK)

## Twist off your filter

Twist your filter anti-clockwise and pull it away from your machine.

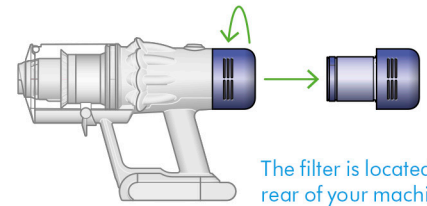

The filter is located at the rear of your machine.

## Tap your filter

Before washing your filter, tap it gently over a bin to remove any loose dust and debris.

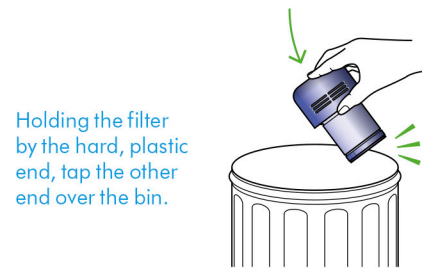

Holding the filter by the hard, plastic end, tap the other end over the bin.

## Wash your filter

Wash with warm, running tap water – gently rubbing your filter with your fingers to remove the dirt.

## Fill and shake

Place your hand over one end of your filter.

Fill the filter with warm tap water.

Place your hand over the open end of the filter and shake it firmly to remove trapped dirt and debris.

Repeat these steps until the water runs clear.

Filter held in upright position, with the wider end in the palm of a hand. Water running from a tap into the narrower end.



Filter with hand over the open end with arrows showing a shaking motion.

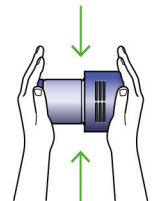

## Shake out the water

Empty the filter and shake firmly to remove excess water.

Shake with the filter in both an upward and downward position.

Keep shaking until there's no water coming from the filter.

A hand holding the filter with the narrow end pointing downwards with droplets of water being shaken from the filter and again, with the end pointing downwards shaking water out.

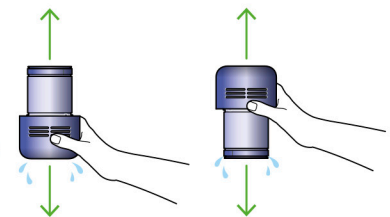

## Dry your filter

Don't dry your filter in a tumble dryer, microwave or near a naked flame.

Important: your filter must be completely dry before you put it back into the machine. Your machine could be damaged if used with a damp filter.



The filter is left to dry with the pleated filter end facing upwards.



# Washing your Fluffy Optic™ cleaner head brush bar

Your Fluffy Optic™ cleaner head has a washable brush bar. To maintain optimum performance, check and wash your brush bar regularly.

Make sure your machine is disconnected from the charger.

## Remove your brush bar

Don't put any part of your machine in a dishwasher or use detergents, polishes or air fresheners.

Press the cleaner head release button on the end of the wand. Place the cleaner head upside down.

Push the end cap up fully and pull the brush bar out of the cleaner head.

Remove the end cap from the brush bar. Don't wash the end cap.

Slide your brush bar out of the cleaner head.

## Wash and dry your brush bar

Hold your brush bar under running water and gently rub to remove any lint or dirt.

Stand your brush bar upright as shown. Leave to dry completely for at least 24 hours.

## Replace your brush bar

Before replacing, check that your brush bar is completely dry.

Reattach the end cap to your brush bar.

Slide your brush bar into the cleaner head. Push the end cap back down to the closed position.

## Cleaning your optic lens

To maintain optimum performance, keep your optic lens clean. Only clean the lens when the cleaner head is not attached to your machine.

Use a soft, dry, lint-free cloth to wipe the lens.

The end cap is located at the side of the cleaner head. Push this upwards to unlock the brush bar. Don't wash the end cap.

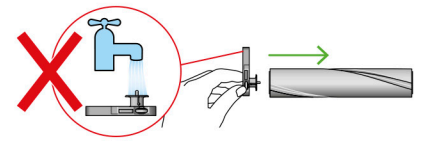
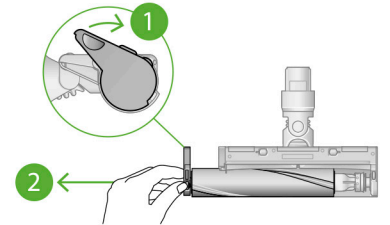

The brush bar has an open end and a closed end. Stand upright, with the closed end facing upwards, to dry.

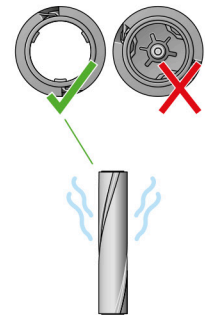

The end cap should be attached to the cleaner head at an angle less than 90°, any angle greater than this will not allow the end cap to close.

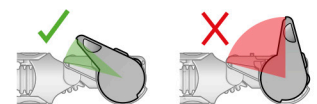
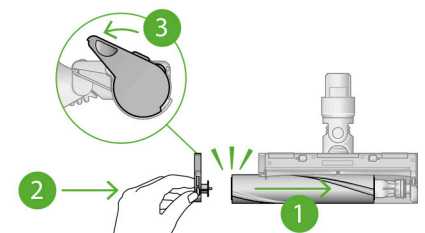

# Cleaning your tools

Don't put any part of your machine in a dishwasher or use detergents, polishes or air fresheners.

Wipe with a damp, lint-free cloth, without touching the connector end.

Make sure your tools are completely dry before using.



Scratch-free dusting brush



Extension hose

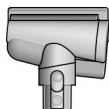

Hair screw tool



Worktop tool



Awkward gap tool

# Looking after your machine

To always get the best performance from your machine, it's important to clean it regularly and check for blockages.

## **Look after your machine**

If your machine is dusty, wipe with a damp lint-free cloth.

Check for blockages in the cleaner head, tools and main body of your machine.

Wash your filter regularly and leave to dry completely.

Don't use detergents or polishes to clean your machine.

## **Look after your battery**

To get the best performance and life from your battery, use Eco mode.

Your machine won't operate or charge if the ambient temperature is below 5°C (41°F). This is designed to protect both the motor and battery.

## **Your serial numbers**

You can find your serial numbers on your machine and battery.

Use your serial number to register.