



Contents

In the box

Download the MyDyson™ app

Getting started

Assembling your headphones

Pairing your headphones

Charging your headphones

Airflow control

Using audio

Active noise cancelling

Audio joystick

LEDs

In-flight adaptor

Changing your filters

Cleaning your headphones

Reassembling your headphones

In the box

Some accessories may not be included.
You can buy additional accessories at
<https://www.dyson.hk/en-HK>



Dyson Zone™ headphones
with air purification

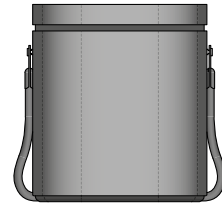

Explorer case¹

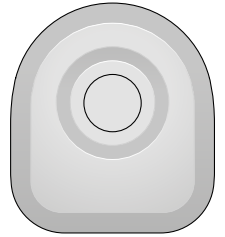

'Quarter Turn'
hard case

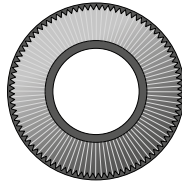

Electrostatic
carbon filters



Soft pouch¹



Visor sleeve

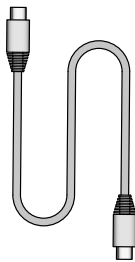

USB-C

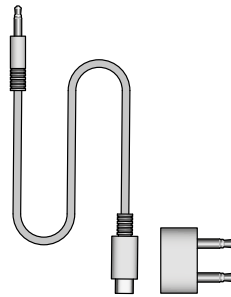

In-flight adaptor kit¹



Visor cleaning brush

1. Dyson Zone™ Absolute Plus only.

Download the MyDyson™ app

An essential part of your experience, the MyDyson™ app lets you control your Dyson Zone™ headphones with air purification – wherever you are. If you haven't already, download the app now for extra features and the latest updates.

Download the MyDyson™ app from the App Store or Google Play. Open the app and follow the on-screen instructions to create a new account.



Apple and the Apple logo are trademarks of Apple Inc., registered in the U.S. and other countries. App Store is a service mark of Apple Inc., registered in the U.S. and other countries. Google Play and the Google Play logo are trademarks of Google Inc.

Getting started

Audio joystick

Lets you control music, adjust volume and access your voice assistant – on the back of your right ear cup.



Download the MyDyson™ app
Control your environment – wherever you are. Access live reporting on air quality and noise, check the status of your battery, filter life and more.

Ergonomic ear cup
Angled at minus 13° and oval-shaped to sit over the ear.

Electrostatic carbon filter

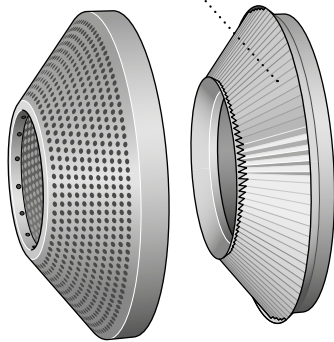

Twist and release filter cover
For hygienic and easy filter replacement.

Auto-activity mode

Control airflow for your activity. Use the button on the left ear cup to scroll through the airflow control, or use the app.



Contactless visor
Attaches to supply purified air.

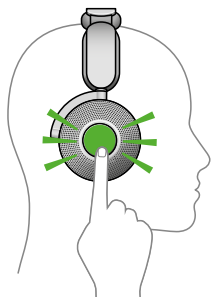

Transparency mode
To switch to Transparency mode, double tap either ear cup. Surrounding sounds are amplified.



Slide adjustor
Adapts to different face shapes and sizes.

USB-C charger
Charge your headphones using the USB-C cable.

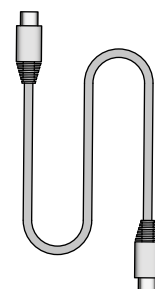

Assembling your headphones

Insert your filters

Twist off both ear cup covers, anti-clockwise.

Hold the filters on the plastic edges and secure them into the ear cups.

Replace the covers and twist them clockwise to secure into position.

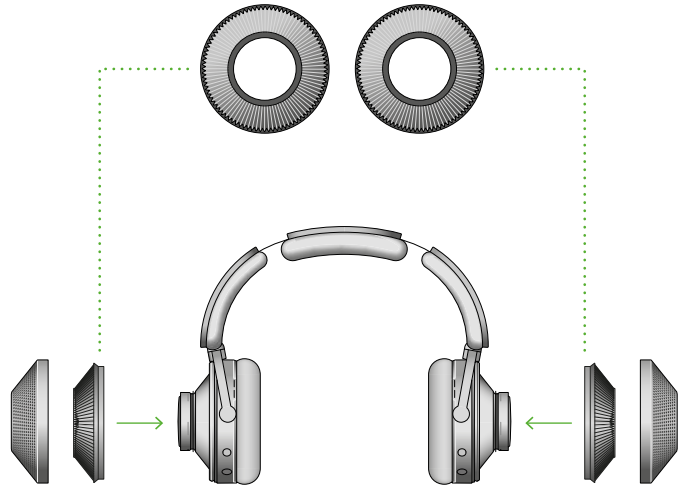
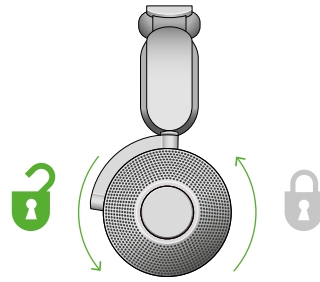

Adjust your headphones

Put your headphones on.

Adjust the headband, sliding both sides until you have a comfortable fit.

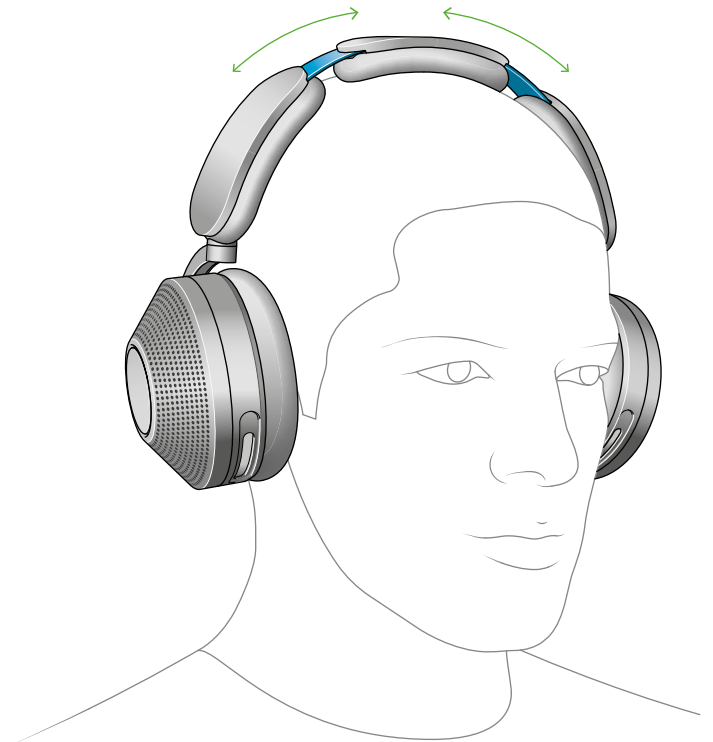

Attach visor

Remove any packaging from the visor and fully extend the visor arms.

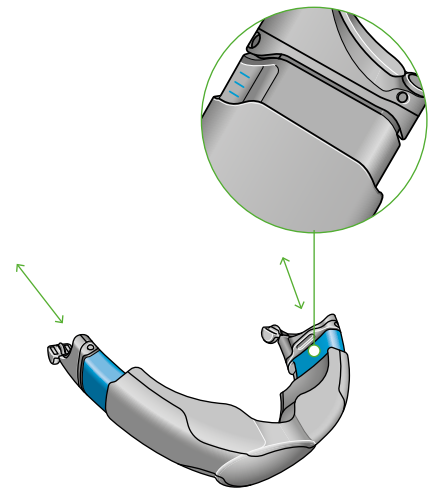
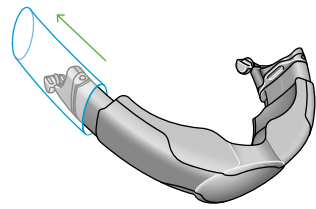

With the visor positioned below your mouth, attach it to each ear cup with the magnetic connectors.

Push the visor up to cover your nose and mouth.

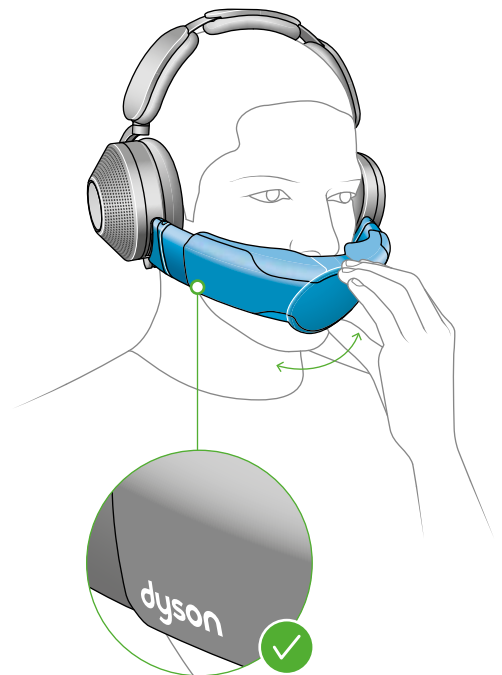

Adjust visor

Adjust the visor until it's in a comfortable position, close to – but not touching – your face. The airflow will start automatically.

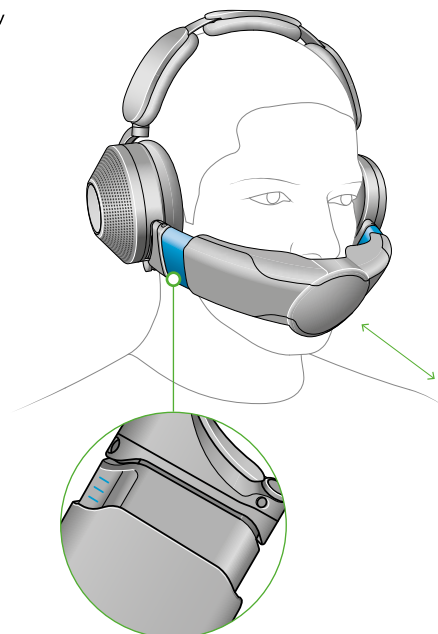

Pairing your headphones

Connecting to the MyDyson™ app

Download the MyDyson™ app from the App Store or Google Play. Open the app and follow the on-screen instructions to create a new account.

If you already have an account, select 'Add machine' and follow the instructions.



Apple and the Apple logo are trademarks of Apple Inc., registered in the U.S. and other countries. App Store is a service mark of Apple Inc., registered in the U.S. and other countries. Google Play and the Google Play logo are trademarks of Google Inc.

Turn on your headphones

Press and hold the Airflow button on your left ear cup to turn on the power. The LED light will turn white.

You can turn them off by holding down the airflow button for 5 seconds when you are not using them. Holding it down for a further 5-10 seconds will reset your headphones.

Pair your headphones

Press and hold the airflow button until the LED light starts to pulse blue.

Your MyDyson™ app will alert you when pairing is complete.

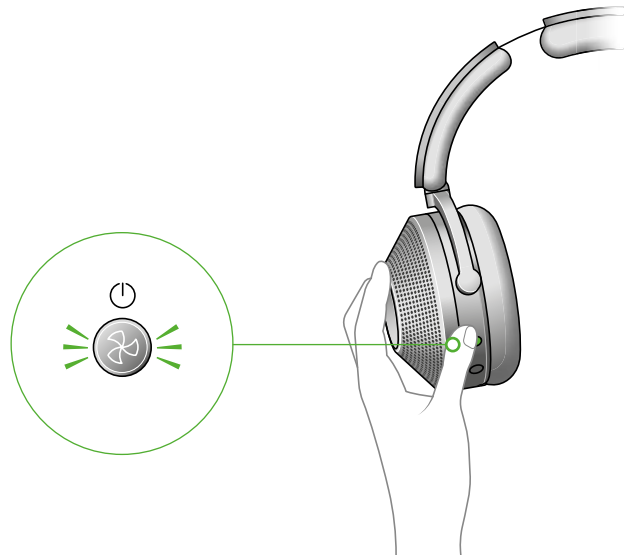

Connect audio using Bluetooth®

Open Bluetooth® in your mobile device's settings menu. Check that Bluetooth® is turned on and select your Dyson Zone™ headphones.

When your device has connected to your headphones, return to the MyDyson™ app.



Charging your headphones

Your headphones will need to have more than 20% charge to run purification.

You can check charge level by pressing the airflow button.

Battery life

The battery life of your headphones with air purification will improve with use. Allow at least 5 hours of initial use to achieve the best runtime performance.

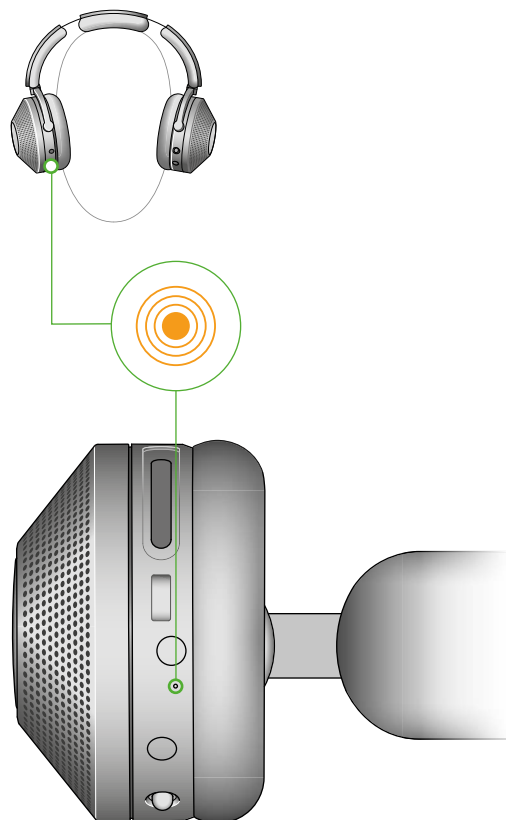

Action and LED behaviour

Battery is more than 20% charged

The LED will turn green.



Battery is less than 20% charged

The LED will turn a solid amber for five seconds.



Charging

When connected to a power supply and charging, the LED will pulse amber. When fully charged, the LED will turn green and then fade to off.



Insufficient charge for purification

The LED will flash amber for five seconds.



Airflow control

Your Dyson Zone™ headphones with air purification will detect your level of activity and adjust the airflow automatically. You can also choose to adjust the levels manually.

Use your MyDyson™ app to select Auto, or adjust the modes manually. Alternatively, use the button on the back of the left ear cup to select modes.

Battery life

You can extend battery life by using low airflow settings.

Auto
Rest
Light
Moderate
Off



Auto mode

Airflow will adapt to your activity level.



Rest

Lowest airflow setting. Battery life is extended in this mode.



Light

Increased airflow setting.



Moderate

Highest available airflow setting.



Battery life

Your battery life will be extended by using low airflow speeds.



Using audio

To play audio through your headphones, you'll need to either connect them using Bluetooth® or the audio cable.

You can play audio through your headphones without the visor being attached.

Use the audio button

Control your audio using the MyDyson™ app or the joystick on the back of your right ear cup.

Play and pause

Press the middle of the joystick to play. Press it again to pause.

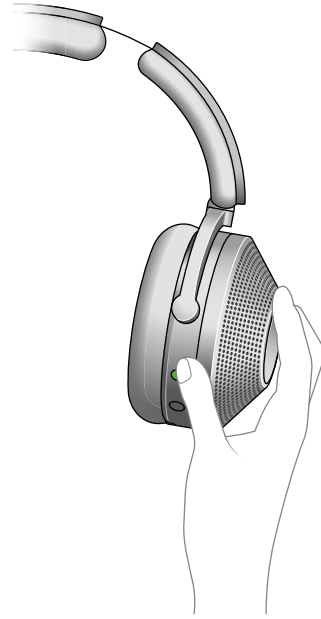
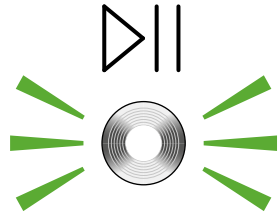

Skip and seek

Tap the joystick on the left or right to skip tracks. Press and hold to fast forward or rewind.

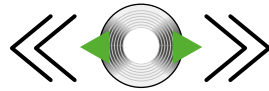

Volume

Push the joystick up or down to adjust the volume.

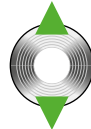

Activating voice assistant

Press and hold the middle of the joystick to activate the voice control on your mobile device.



Active noise cancelling

Use Active noise cancelling (ANC) to reduce the background noise around you.

Isolation mode

The maximum level of ANC, reducing surrounding and background noise. This is the default setting for your headphones.

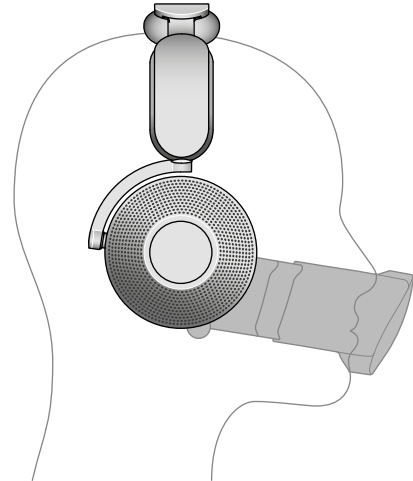

Transparency mode

To toggle to Transparency mode, double tap either ear cap. Surrounding sounds are amplified.

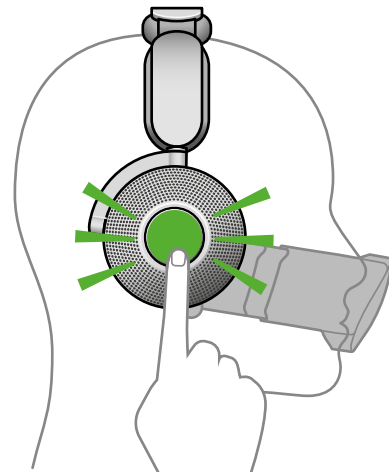

Conversation mode

Flip the visor down to pause airflow, audio and noise cancelling. Voices are amplified so you can hear with your headphones on.

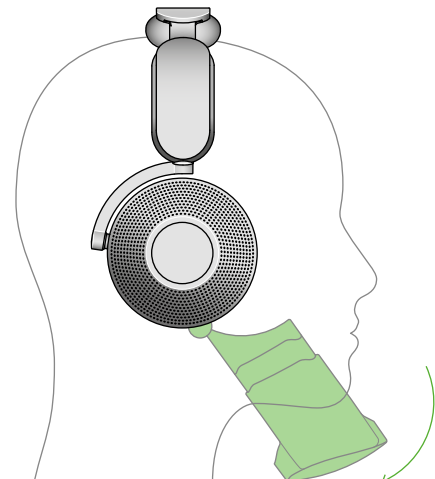

Audio joystick

How to use the Audio joystick
Control your audio using the joystick on the back of your right ear cup.



Action

At all times

Increase volume slowly
Press joystick up.



Increase volume quickly
Press joystick up – volume increases until joystick is released.



Decrease volume slowly
Press joystick down.



Trigger voice assistant
Press and hold joystick.



While listening to audio

Play/pause audio
Press joystick once to play/pause audio.



Skip to previous audio file (or restart track)
Press joystick to the left.



Rewind
Press joystick to the left.



Skip to next audio file
Tap joystick to the right once.



Fast forward
Press and hold joystick to the right.



While using the voice assistant on device

End use of voice assistant
Press joystick.



While call is ringing

Accept call
Press joystick.



Decline call
Press and hold joystick.



While call is in progress

End call
Press joystick.



LEDs

LEDs will let you know when your Dyson Zone™ headphones with air purification need your attention.

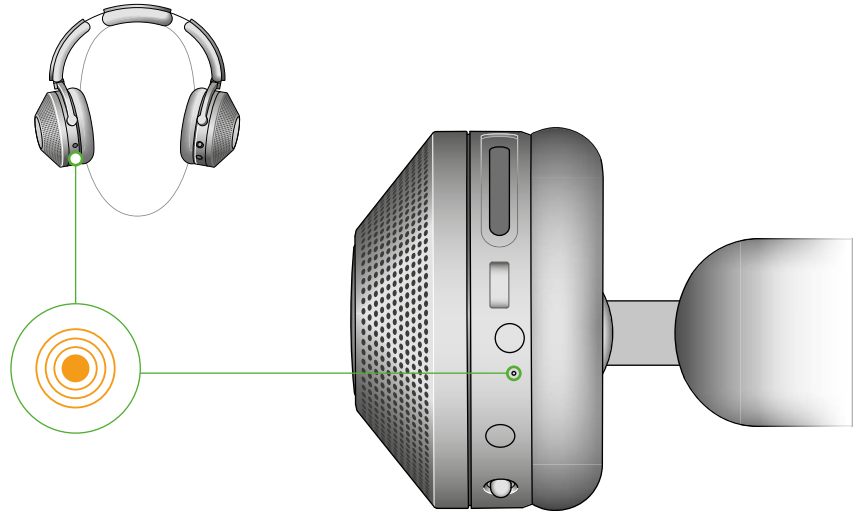

Action

Power on
White LED – momentary (off to on).



Power off
White LED – momentary (on to off).



Battery

Battery is over 20% charged
When taken off head or left button pressed – green LED.



Battery is under 20% charged
When taken off head or left button pressed – orange LED.



Connected to power – fully charged
Constant green LED for 5 minutes, then fade to off.



Connected to power – charging
Orange LED – pulse while charging.



Insufficient charge to use the purifier
Orange LED – flash for 5 seconds.



Battery charge under 20%
Orange LED – solid for 5 seconds.



Bluetooth®

Bluetooth® in discoverable mode
Blue LED – continuous pulse.



Bluetooth® successfully connected
Blue LED – solid. Audio – welcome tone.



Filter

Filter needs changing
Pink LED – pulse.



Alerts

Seek Dyson support
Red LED – flash for 5 seconds.



Update installing
White LED – pulsed flashing.



In-flight adaptor²

Connect the In-flight cable to the 2-pin adaptor, then plug into the plane's entertainment system via the audio port.

The In-flight adaptor will only charge your Dyson Zone™ headphones with air purification when the USB-C cable is also used.

Please note that the audio controls on your Dyson Zone™ headphones with air purification will not function when the In-flight adaptor is in use.



² Accessory only come with Dyson Zone™ Absolute+ headphones with air purification.



Warning

The In-flight 2-pin adaptor is for connection to an audio outlet only. Plugging in to a mains socket outlet may result in a fire or pose a risk of an electric shock.

Changing your filters

Filter life

Your MyDyson™ app and headphones will alert you when your filter life is running low. The filter life will depend on the amount of time you use your headphones and the level of your activity.

Your filters are not washable and should be replaced once the MyDyson™ app has alerted you to do so.

Remove the cover

Twist the covers on the ear cups until they release.

Remove the filters

Lift out the filters carefully. Avoid dropping any dust into the ear cups. Dispose of the filters.

Insert filters

Remove the new filters from any packaging and place in the ear cups.

Replace the covers and twist clockwise to lock into position.

Once you have changed your filters it is important to remember to reset your filter life in the MyDyson™ app.

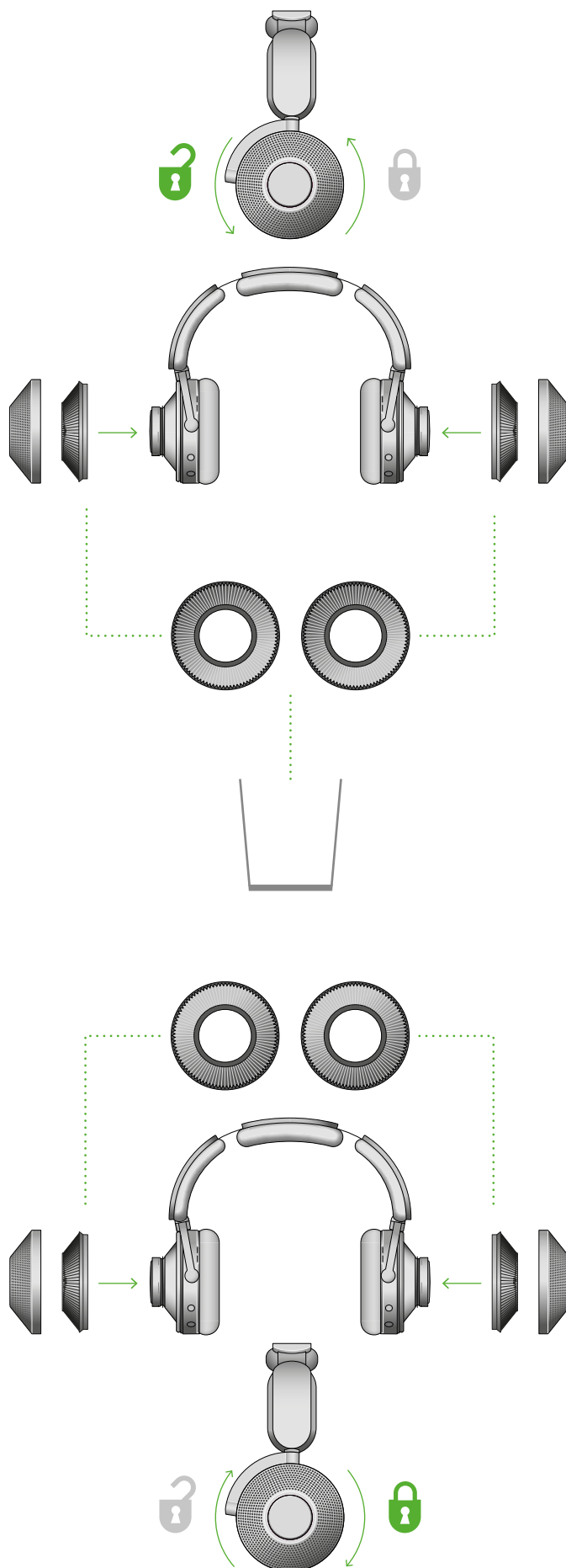

Cleaning your Dyson Zone™ headphones with air purification

It is important to carry out regular cleaning of your headphones to maintain maximum performance. Allow enough time to dry your headphones before you need to use them again.

Due to the materials and manufacturing processes used, your machine inclusive of the packaging, may produce a slight odour.

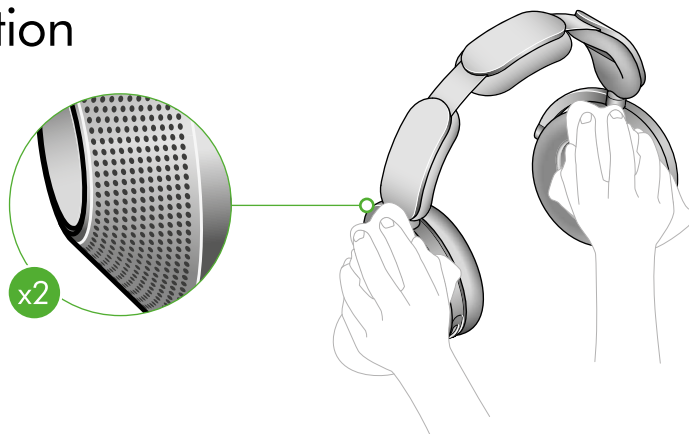

Quick clean

Ear covers

Wipe away dust or debris from the perforations in the ear cup covers with a soft, damp, lint-free cloth.

Ear cushions

Wipe away dust or debris with a soft, damp, lint-free cloth.

Visor

Wipe away dust or debris with a soft, damp, lint-free cloth.



Regular cleaning

Remove the visor

Push the visor down and gently pull it away from the ear cups.

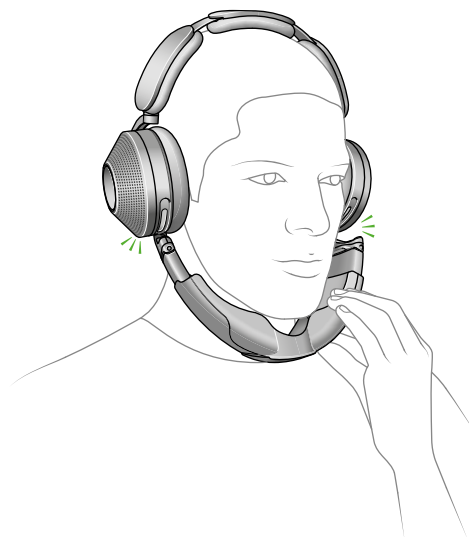

Pinch the outer edges of the mesh until it pops out of the visor.

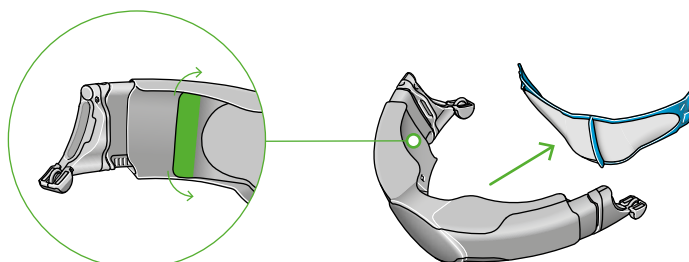

Slide the side extensions out and unclip from the visor.

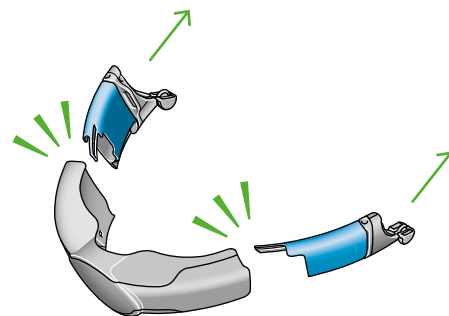

Wash visor

Wash the visor and mesh with warm water and dish soap. Use the Dyson visor cleaning brush to reach all areas.

Rinse all parts thoroughly.

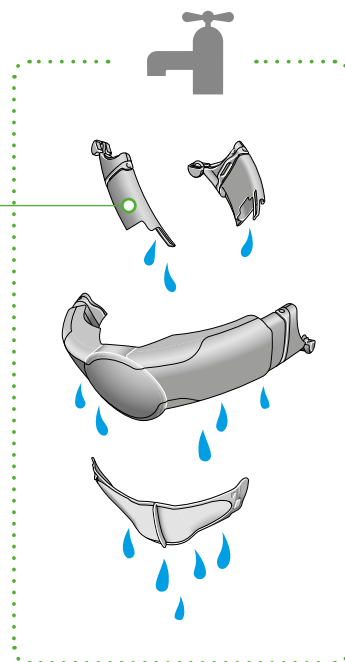
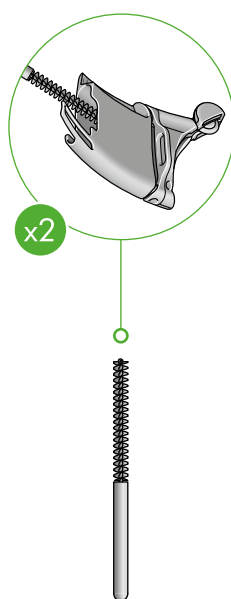

Dry visor

Leave your visor to dry in a well-ventilated, warm place.

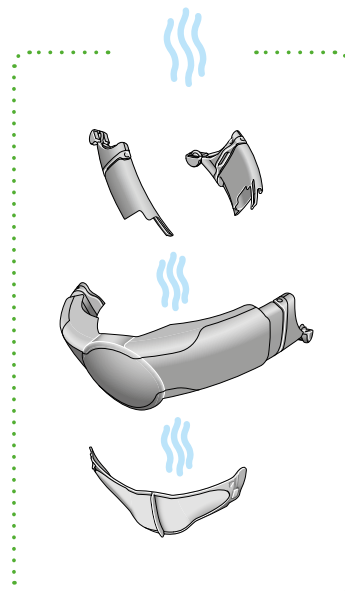

Reassembling your headphones

Reassemble visor

Make sure all parts of your visor are completely dry before reassembling.

Slide in side extensions until they click into position.

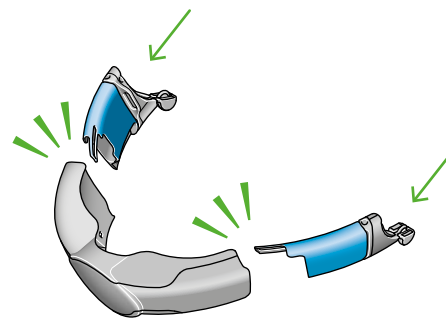

Clip in the inner mesh.

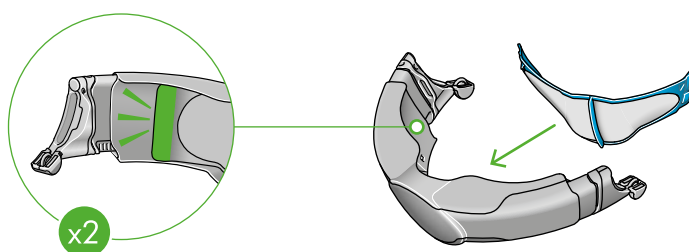

Reattach the visor to your headphones.

